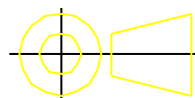

FIGURE 1 PRINCIPAL DIMENSIONS AND DATUM

FOR REVISION UPDATE PLEASE REFER TO HISTORY OF CHANGES.

 **Carsem** Your Technology Partner

REV F	DWG NO: PKGMQ0001		FILE: \PKGMQ0001
	APP'D	KH LEE	MQFP
	CHECKED	ARAVEN	PACKAGE OUTLINE
	DESIGNED	ARAVEN	
	DRAWN	KHALIM	SHEET : 1 OF 12



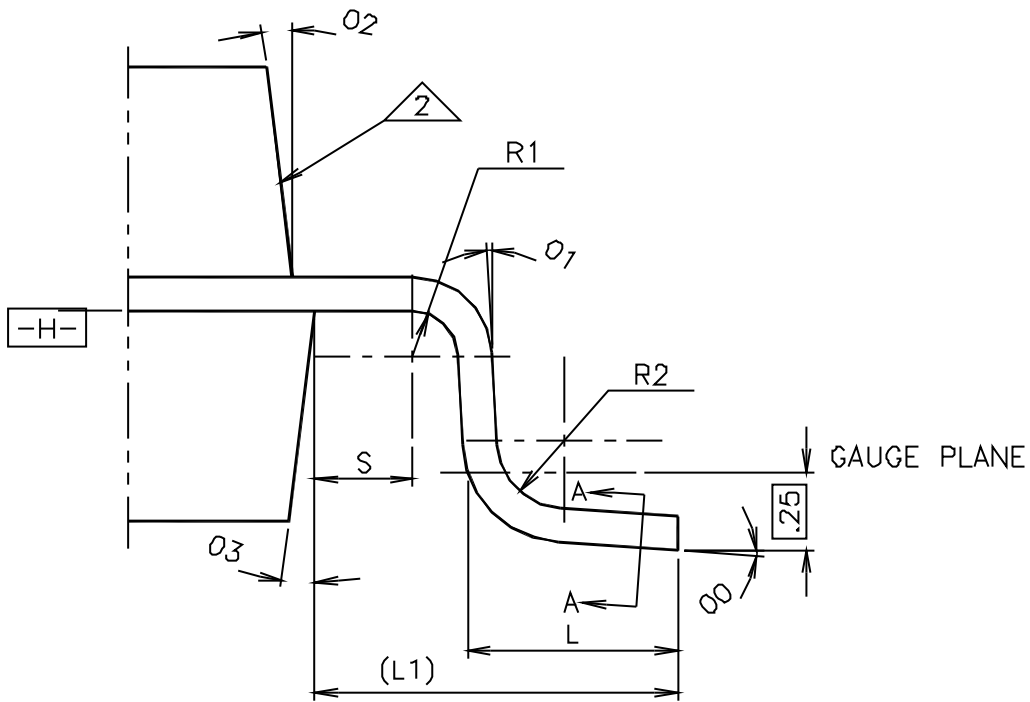

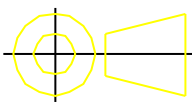

FIG 2 DETAIL C

FOR REVISION UPDATE PLEASE REFER TO HISTORY OF CHANGES.

 **Carsem** Your Technology Partner

REV F	DWG NO: PKGMQ0001			FILE: \PKGMQ0001
	APP'D	KH LEE		MQFP PACKAGE OUTLINE
	CHECKED	ARAVEN		
	DESIGNED	ARAVEN		
	DRAWN	KHALIM		SHEET : 2 OF 12

COMMON DIMENSIONS

SYMBOL	MO-143			NOTE	MO-112			NOTE	MS-022			NOTE
	MIN	NOM	MAX		MIN	NOM	MAX		MIN	NOM	MAX	
R1	0.08	----	----		0.13	----	----		0.13	----	----	
R2	0.08	----	0.25		0.13	----	0.30		0.13	----	0.30	
00	0°	3.5°	7°		0°	3.5°	7°		0°	3.5°	7°	
01	0°	----	----		0°	----	----		0°	----	----	
02	5°	----	16°	17	5°	----	16°		5°	----	16°	
03	5°	----	16°	17	5°	----	16°		5°	----	16°	
c	0.09	----	0.20		0.11	----	0.23		0.11	----	0.23	
c1	0.09	----	0.16		0.11	----	0.17		0.11	----	0.17	
L	0.45	0.60	0.75		0.73	0.88	1.03		0.73	0.88	1.03	
L1	1.30 REF				1.95 REF				1.60 REF			
S	0.20	----	----		0.40	----	----		0.20	----	----	

TOLERANCE OF FORM AND POSITIONS

aaa	0.20		0.25		0.25	
bbb	0.20		0.20		0.20	
ddd	----		0.10		0.10	
eee	0.08		----		----	
fff	----		0.10		0.10	
ggg	0.05		----		----	

COMMON DIMENSIONS

SYMBOL	NJR - 1			NOTE				NOTE				NOTE
	MIN	NOM	MAX		MIN	NOM	MAX		MIN	NOM	MAX	
R1	0.13	----	----									
R2	0.13	----	0.30									
00	0°	5°	7°									
01	0°	----	----									
02	5°	----	16°									
03	5°	----	16°									
c	0.09	----	0.20									
c1	0.09	----	0.16									
L	0.60	0.80	1.00									
L1	1.80 REF											
S	0.20	----	----									

TOLERANCE OF FORM AND POSITIONS

aaa	0.25					
bbb	0.20					
ddd	0.10					
eee	----					
fff	0.10					
ggg	----					

FOR REVISION UPDATE PLEASE REFER TO HISTORY OF CHANGES.

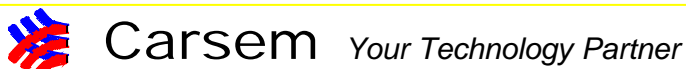

REV
F

DWG NO: PKGMQ0001	
APP'D	KH LEE
CHECKED	ARAVEN
DESIGNED	ARAVEN
DRAWN	KHALIM

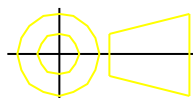

FILE: \PKGMQ0001
MQFP PACKAGE OUTLINE
SHEET : 3 OF 12

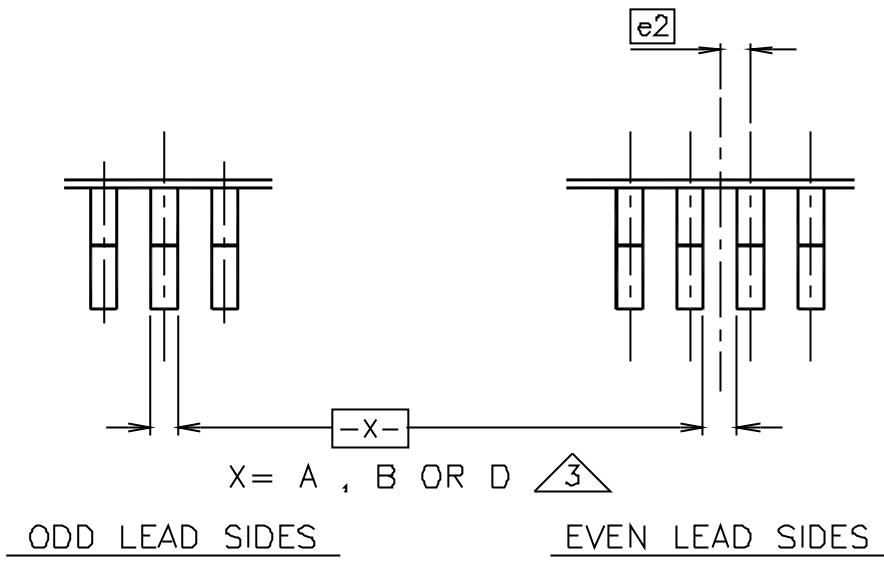

DETAIL A

SECTION A-A

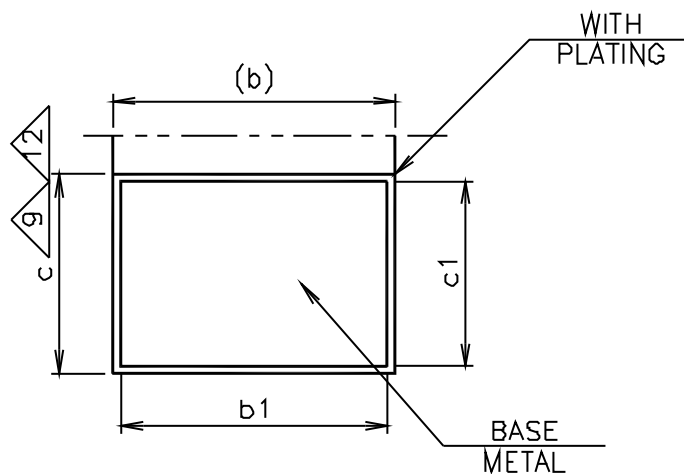

FOR REVISION UPDATE PLEASE REFER TO HISTORY OF CHANGES.

Carsem Your Technology Partner

REV F	DWG NO: PKGMQ0001			FILE: \PKGMQ0001
	APP'D	KH LEE		MQFP PACKAGE OUTLINE
	CHECKED	ARAVEN		
	DESIGNED	ARAVEN		
	DRAWN	KHALIM		SHEET : 4 OF 12

NOTES:

- 1 ALL DIMENSIONS AND TOLERANCING CONFORM TO ANSI Y14.5M-1982.
- 2 DATUM PLANE -H- IS LOCATED AT THE BOTTOM OF THE MOLD PARTING LINE COINCIDENT WITH WHERE THE LEAD EXITS THE BODY.
- 3 DATUM A-B AND -D- TO BE DETERMINED AT DATUM PLANE -H-
- 4 TO BE DETERMINED AT SEATING PLANE -C-
- 5 DIMENSIONS D1 AND E1 DO NOT INCLUDE MOLD PROTRUSION, ALLOWABLE PROTRUSION IS 0.25mm PER SIDE. DIMENSIONS D1 AND E1 DO INCLUDE MOLD MISMATCH AND ARE DETERMINED AT DATUM PLANE -H-
- 6 DETAILS OF PIN 1 IDENTIFIER ARE OPTIONAL BUT MUST BE LOCATED WITHIN THE ZONE INDICATED.
- 7 REGARDLESS OF THE RELATIVE SIZE OF THE UPPER AND LOWER BODY SECTIONS, DIMENSIONS D1 AND E1 ARE DETERMINED AT THE LARGEST FEATURE OF THE BODY EXCLUSIVE OF MOLD FLASH AND GATE BURRS, BUT INCLUDING ANY MISMATCH BETWEEN THE UPPER AND LOWER SECTIONS OF THE MOLDED BODY.
- 8 ALL DIMENSIONS ARE IN MILLIMETER.
- 9 DIMENSION b DOES NOT INCLUDE MOLD PROTRUSION, ALLOWABLE DAMBAR PROTRUSION SHALL BE 0.08mm TOTAL IN EXCESS OF THE b DIMENSION AT MAXIMUM MATERIAL CONDITION. DAMBAR CANNOT BE LOCATED ON THE LOWER RADIUS OR THE LEAD FOOT.
- 10 EXACT SHAPE AND SIZE OF THIS FEATURE IS OPTIONAL.
- 11 N IS THE NUMBER OF LEADS.
- 12 THESE DIMENSIONS APPLY TO THE FLAT SECTION OF THE LEAD BETWEEN 0.10mm AND 0.25mm FROM THE LEAD TIP.
- 13 THE TOP PACKAGE BODY SIZE MAY BE SMALLER THAN THE BOTTOM PACKAGE BODY SIZE.
- 14 RECTANGULAR VARIATION HAS 30 AND 20 LEADS ON SIDES D AND E RESPECTIVELY.
- 15 A1 IS DEFINED AS THE DISTANCE FROM THE SEATING PLANE TO THE LOWEST POINT OF THE PACKAGE BODY.
- 16 FOR N.J.R. PACKAGES THE FOLLOWING APPLY;
 - 16.1. FOR 2.6MM FOOT PRINT OPTIONS , REFER TO MO-143 FOR COMMON DIMENSIONS.
 - 16.2. FOR 3.2MM FOOT PRINT OPTIONS , REFER TO MS-022 FOR COMMON DIMENSIONS.
 - 16.3. FOR 3.9MM FOOT PRINT OPTIONS , REFER TO MO-112 FOR COMMON DIMENSIONS.
 - 16.4. FOR 3.6MM FOOT PRINT OPTIONS , REFER TO N.J.R-1 FOR COMMON DIMENSIONS.
- 17 FOR THE PACKAGE SIZE 28x28 AND 32x32 UNDER OPTION MO-143 , THE DRAFT ANGLE FOR TOP PACKAGE AND BTM PACKAGE IS BETWEEN 5°~16°.

FOR REVISION UPDATE PLEASE REFER TO HISTORY OF CHANGES.

 **Carsem** Your Technology Partner

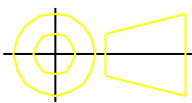
REV F	DWG NO: PKGMQ0001			FILE: \PKGMQ0001
	APP'D	KH LEE		MQFP PACKAGE OUTLINE
	CHECKED	ARAVEN		
	DESIGNED	ARAVEN		
	DRAWN	KHALIM		SHEET : 5 OF 12

VARIATIONS												
SYM BOL	MS-022			NOTE	MO-112			NOTE	MO-112			NOTE
	AB				AA-1				AA-2			
	SQUARE				SQUARE				SQUARE			
	MIN	NOM	MAX		MIN	NOM	MAX		MIN	NOM	MAX	
A	1.80	2.13	2.45		2.20	2.30	2.45		1.95	2.13	2.35	
A1	0.00	0.13	0.25		0.25	0.30	0.35		0.00	0.13	0.25	
A2	1.80	2.00	2.20		1.95	2.00	2.10		1.95	2.00	2.10	
b	0.30	---	0.45	9	0.30	---	0.45	9	0.30	---	0.45	9
b1	0.30	0.35	0.40		0.30	0.35	0.40		0.30	0.35	0.40	
D	13.20 BSC			4	13.90 BSC			4	13.90 BSC			4
D1	10.00 BSC			5,7	10.00 BSC			5,7	10.00 BSC			5,7
D2	8.00 REF				8.00 REF				8.00 REF			
E	13.20 BSC			4	13.90 BSC			4	13.90 BSC			4
E1	10.00 BSC			5,7	10.00 BSC			5,7	10.00 BSC			5,7
E2	8.00 REF				8.00 REF				8.00 REF			
ccc	0.20				0.20				0.20			
e	0.80 BSC				0.80 BSC				0.80 BSC			
N	44				44				44			
NOTE	1 , 8				1 , 8				1 , 8			
REF	11-320				11-286				11-286			
ISSUE	A				A				A			

VARIATIONS												
SYM BOL	MS-022			NOTE	MO-112			NOTE	MO-112			NOTE
	AC				AC-1				AC-2			
	SQUARE				SQUARE				SQUARE			
	MIN	NOM	MAX		MIN	NOM	MAX		MIN	NOM	MAX	
A	1.80	2.13	2.45		2.20	2.30	2.45		1.95	2.13	2.35	
A1	0.00	0.13	0.25		0.25	0.30	0.35		0.00	0.13	0.25	
A2	1.80	2.00	2.20		1.95	2.00	2.10		1.95	2.00	2.10	
b	0.22	---	0.38	9	0.22	---	0.38	9	0.22	---	0.38	9
b1	0.22	0.30	0.33		0.22	0.30	0.33		0.22	0.30	0.33	
D	13.20 BSC			4	13.90 BSC			4	13.90 BSC			4
D1	10.00 BSC			5,7	10.00 BSC			5,7	10.00 BSC			5,7
D2	7.80 REF				7.80 REF				7.80 REF			
E	13.20 BSC			4	13.90 BSC			4	13.90 BSC			4
E1	10.00 BSC			5,7	10.00 BSC			5,7	10.00 BSC			5,7
E2	7.80 REF				7.80 REF				7.80 REF			
ccc	0.13				0.12				0.12			
e	0.65 BSC				0.65 BSC				0.65 BSC			
N	52				52				52			
NOTE	1 , 8				1 , 8				1 , 8			
REF	11-320				11-286				11-286			
ISSUE	A				A				A			

FOR REVISION UPDATE PLEASE REFER TO HISTORY OF CHANGES.

 **Carsem** Your Technology Partner

REV
F

DWG NO: PKGMQ0001

APP'D	KH LEE
CHECKED	ARAVEN
DESIGNED	ARAVEN
DRAWN	KHALIM

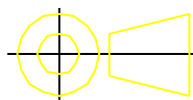

FILE: \PKGMQ0001

MQFP
PACKAGE OUTLINE

SHEET : 6 OF 12

VARIATIONS												
SYMBOL	MS-022			NOTE	MS-022			NOTE	MS-022			NOTE
	BB				BE				GA-2			
	SQUARE				SQUARE				RECTANGULAR			
	MIN	NOM	MAX		MIN	NOM	MAX		MIN	NOM	MAX	
A	1.80	2.15	2.45		2.50	2.95	3.15		2.50	2.83	3.15	
A1	0.00	0.15	0.25		0.00	0.15	0.25		0.00	0.13	0.25	
A2	1.80	2.00	2.20		2.50	2.80	2.90		2.50	2.70	2.90	
b	0.30	---	0.45	9	0.30	---	0.45	9	0.35	---	0.50	9
b1	0.30	0.35	0.40		0.30	0.35	0.40		0.35	0.40	0.45	
D	17.20 BSC			4	17.20 BSC			4	23.20 BSC			4
D1	14.00 BSC			5,7	14.00 BSC			5,7	20.00 BSC			5,7
D2	12.00 REF				12.00 REF				18.00 REF			
E	17.20 BSC			4	17.20 BSC			4	17.20 BSC			4
E1	14.00 BSC			5,7	14.00 BSC			5,7	14.00 BSC			5,7
E2	12.00 REF				12.00 REF				12.00 REF			
ccc	0.20				0.20				0.20			
e	0.80 BSC				0.80 BSC				1.00 BSC			
N	64				64				64			
NOTE	1 , 8				1 , 8				1 , 8			
REF	11-320				11-286				11-286			
ISSUE	A				A				A			

VARIATIONS												
SYMBOL	MS-022			NOTE	MO-112			NOTE	MS-022			NOTE
	GA-1				CA-1				GB-2			
	RECTANGULAR				RECTANGULAR				RECTANGULAR			
	MIN	NOM	MAX		MIN	NOM	MAX		MIN	NOM	MAX	
A	2.75	3.00	3.40		2.80	3.00	3.40		2.50	2.83	3.15	
A1	0.25	0.30	0.50		0.25	0.30	0.50		0.00	0.13	0.25	
A2	2.50	2.70	2.90		2.55	2.70	2.90		2.50	2.70	2.90	
b	0.35	---	0.50	9	0.35	---	0.50	9	0.30	---	0.45	9
b1	0.35	0.40	0.45		0.35	0.40	0.45		0.30	0.35	0.40	
D	23.20 BSC			4	23.90 BSC			4	23.20 BSC			4
D1	20.00 BSC			5,7	20.00 BSC			5,7	20.00 BSC			5,7
D2	18.00 REF				18.00 REF				18.40 REF			
E	17.20 BSC			4	17.90 BSC			4	17.20 BSC			4
E1	14.00 BSC			5,7	14.00 BSC			5,7	14.00 BSC			5,7
E2	12.00 REF				12.00 REF				12.00 REF			
ccc	0.20				0.20				0.20			
e	1.00 BSC				1.00 BSC				0.80 BSC			
N	64				64				80			
NOTE	1 , 8				1 , 8				1 , 8			
REF	11-320				11-286				11-320			
ISSUE	A				A				A			

FOR REVISION UPDATE PLEASE REFER TO HISTORY OF CHANGES.

 **Carsem** Your Technology Partner

REV
F

DWG NO: PKGMQ0001

APP'D	KH LEE
CHECKED	ARAVEN
DESIGNED	ARAVEN
DRAWN	KHALIM

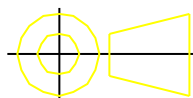

FILE: \PKGMQ0001

MQFP
PACKAGE OUTLINE

SHEET : 7 OF 12

VARIATIONS												
SYM BOL	MS-022			NOTE	MO-112			NOTE	MS-022			NOTE
	GB-1				CB-1				GC-2			
	RECTANGULAR				RECTANGULAR				RECTANGULAR			
	MIN	NOM	MAX		MIN	NOM	MAX		MIN	NOM	MAX	
A	2.75	3.00	3.40		2.80	3.00	3.40		2.50	2.83	3.15	
A1	0.25	0.30	0.50		0.25	0.30	0.50		0.00	0.13	0.25	
A2	2.50	2.70	2.90		2.55	2.70	2.90		2.50	2.70	2.90	
b	0.30	---	0.45	9	0.30	---	0.45	9	0.22	---	0.38	9
b1	0.30	0.35	0.40		0.30	0.35	0.40		0.22	0.30	0.33	
D	23.20 BSC			4	23.90 BSC			4	23.20 BSC			4
D1	20.00 BSC			5,7	20.00 BSC			5,7	20.00 BSC			5,7
D2	18.40 REF				18.40 REF				18.85 REF			
E	17.20 BSC			4	17.90 BSC			4	17.20 BSC			4
E1	14.00 BSC			5,7	14.00 BSC			5,7	14.00 BSC			5,7
E2	12.00 REF				12.00 REF				12.35 REF			
ccc	0.20				0.20				0.13			
e	0.80 BSC				0.80 BSC				0.65 BSC			
N	80				80				100			
NOTE	1 , 8				1 , 8				1 , 8			
REF	11-320				11-286				11-320			
ISSUE	A				A				A			

VARIATIONS												
SYM BOL	MS-022			NOTE	MO-112			NOTE	N.J.R			NOTE
	GC-1				CC-1				ZZ1			
	RECTANGULAR				RECTANGULAR				SQUARE			
	MIN	NOM	MAX		MIN	NOM	MAX		MIN	NOM	MAX	
A	2.75	3.00	3.40		2.80	3.00	3.40		3.45	3.70	4.10	
A1	0.25	0.30	0.50		0.25	0.30	0.50		0.25	0.30	0.50	
A2	2.50	2.70	2.90		2.55	2.70	2.90		3.20	3.40	3.60	
b	0.22	---	0.38	9	0.22	---	0.38	9	0.30	---	0.45	9
b1	0.22	0.30	0.33		0.22	0.30	0.33		0.30	0.35	0.40	
D	23.20 BSC			4	23.90 BSC			4	30.60 BSC			4
D1	20.00 BSC			5,7	20.00 BSC			5,7	28.00 BSC			5,7
D2	18.85 REF				18.85 REF				23.20 REF			
E	17.20 BSC			4	17.90 BSC			4	30.60 BSC			4
E1	14.00 BSC			5,7	14.00 BSC			5,7	28.00 BSC			5,7
E2	12.35 REF				12.35 REF				23.20 REF			
ccc	0.13				0.12				---			
e	0.65 BSC				0.65 BSC				0.80 BSC			
N	100				100				120			
NOTE	1 , 8				1 , 8				1 , 8 , 16.1			
REF	11-320				11-286				---			
ISSUE	A				A				---			

FOR REVISION UPDATE PLEASE REFER TO HISTORY OF CHANGES.

 **Carsem** Your Technology Partner

REV
F

DWG NO: PKGMQ0001

APP'D	KH LEE
CHECKED	ARAVEN
DESIGNED	ARAVEN
DRAWN	KHALIM

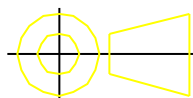

FILE: \PKGMQ0001

MQFP
PACKAGE OUTLINE

SHEET : 8 OF 12

VARIATIONS												
SYM BOL	MS-022			NOTE	N.J.R			NOTE	N.J.R			NOTE
	DA-1				ZZ2				ZZ3			
	SQUARE				RECTANGULAR				RECTANGULAR			
	MIN	NOM	MAX		MIN	NOM	MAX		MIN	NOM	MAX	
A	3.45	3.70	4.10		2.75	3.00	3.40		2.75	3.00	3.40	
A1	0.25	0.30	0.50		0.25	0.30	0.50		0.25	0.30	0.50	
A2	3.20	3.40	3.60		2.50	2.70	2.90		2.50	2.70	2.90	
b	0.30	---	0.45	9	0.17	---	0.27	9	0.17	---	0.27	9
b1	0.30	0.35	0.40		0.17	0.20	0.23		0.17	0.20	0.23	
D	31.20 BSC			4	23.90 BSC			4	23.20 BSC			4
D1	28.00 BSC			5, 7	20.00 BSC			5, 7	20.00 BSC			5, 7
D2	23.20 REF				18.50 REF				18.50 REF			
E	31.20 BSC			4	17.90 BSC			4	17.20 BSC			4
E1	28.00 BSC			5, 7	14.00 BSC			5, 7	14.00 BSC			5, 7
E2	23.20 REF				12.50 REF				12.50 REF			
ccc	0.20				---				---			
e	0.80 BSC				0.50 BSC				0.50 BSC			
N	120				128				128			
NOTE	1, 8				1.8, 16.3				1.8, 16.2			
REF	11-320				---				---			
ISSUE	A				---				---			

VARIATIONS												
SYM BOL	N.J.R			NOTE	N.J.R			NOTE	MS-022			NOTE
	ZZ4				ZZ5				DB-1			
	RECTANGULAR				SQUARE				SQUARE			
	MIN	NOM	MAX		MIN	NOM	MAX		MIN	NOM	MAX	
A	2.50	2.83	3.15		3.45	3.70	4.10		3.45	3.70	4.10	
A1	0.00	0.13	0.25		0.25	0.30	0.50		0.25	0.30	0.50	
A2	2.50	2.70	2.90		3.20	3.40	3.60		3.20	3.40	3.60	
b	0.17	---	0.27	9	0.30	---	0.45	9	0.30	---	0.45	9
b1	0.17	0.20	0.23		0.30	0.35	0.40		0.30	0.35	0.40	
D	23.20 BSC			4	30.60 BSC			4	31.20 BSC			4
D1	20.00 BSC			5, 7	28.00 BSC			5, 7	28.00 BSC			5, 7
D2	18.50 REF				24.80 REF				24.80 REF			
E	17.20 BSC			4	30.60 BSC			4	31.20 BSC			4
E1	14.00 BSC			5, 7	28.00 BSC			5, 7	28.00 BSC			5, 7
E2	12.50 REF				24.80 REF				24.80 REF			
ccc	---				---				0.20			
e	0.50 BSC				0.80 BSC				0.80 BSC			
N	128				128				128			
NOTE	1.8, 16.2				1.8, 16.1				1, 8			
REF	---				---				11-320			
ISSUE	---				---				A			

FOR REVISION UPDATE PLEASE REFER TO HISTORY OF CHANGES.

 **Carsem** Your Technology Partner

REV
F

DWG NO: PKGMQ0001	
APP'D	KH LEE
CHECKED	ARAVEN
DESIGNED	ARAVEN
DRAWN	KHALIM

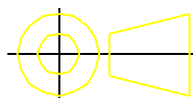

FILE: \PKGMQ0001
MQFP PACKAGE OUTLINE
SHEET : 9 OF 12

VARIATIONS												
SYM BOL	N.J.R			NOTE	MS-022			NOTE	MS-022			NOTE
	ZZ6				DC-1				DD-1			
	SQUARE				SQUARE				SQUARE			
	MIN	NOM	MAX		MIN	NOM	MAX		MIN	NOM	MAX	
A	3.45	3.70	4.10		3.45	3.70	4.10		3.45	3.70	4.10	
A1	0.25	0.30	0.50		0.25	0.30	0.50		0.25	0.30	0.50	
A2	3.20	3.40	3.60		3.20	3.40	3.60		3.20	3.40	3.60	
b	0.22	---	0.38	9	0.22	---	0.38	9	0.22	---	0.38	9
b1	0.22	0.30	0.33		0.22	0.30	0.33		0.22	0.30	0.33	
D	30.60 BSC			4	31.20 BSC			4	31.20 BSC			4
D1	28.00 BSC			5,7	28.00 BSC			5,7	28.00 BSC			5,7
D2	22.75 REF				22.75 REF				25.35 REF			
E	30.60 BSC			4	31.20 BSC			4	31.20 BSC			4
E1	28.00 BSC			5,7	28.00 BSC			5,7	28.00 BSC			5,7
E2	22.75 REF				22.75 REF				25.35 REF			
ccc	---				0.13				0.13			
e	0.65 BSC				0.65 BSC				0.65 BSC			
N	144				144				160			
NOTE	16.1 , 1.8				1 , 8				1 , 8			
REF	- - -				11-320				11-320			
ISSUE	- - -				A				A			

VARIATIONS												
SYM BOL	N.J.R			NOTE	MO-143			NOTE	N.J.R			NOTE
	ZZ7				FA-1				ZZ8			
	SQUARE				SQUARE				SQUARE			
	MIN	NOM	MAX		MIN	NOM	MAX		MIN	NOM	MAX	
A	3.45	3.70	4.10		3.45	3.70	4.10		3.45	3.70	4.10	
A1	0.25	0.30	0.50		0.25	0.30	0.50		0.25	0.30	0.50	
A2	3.20	3.40	3.60		3.20	3.40	3.60		3.20	3.40	3.60	
b	0.22	---	0.38	9	0.17	---	0.27	9	0.17	---	0.27	9
b1	0.22	0.30	0.33		0.17	0.20	0.23		0.17	0.20	0.23	
D	30.60 BSC			4	30.60 BSC			4	31.20 BSC			4
D1	28.00 BSC			5,7	28.00 BSC			5,7	28.00 BSC			5,7
D2	25.35 REF				25.50 REF				25.50 REF			
E	30.60 BSC			4	30.60 BSC			4	31.20 BSC			4
E1	28.00 BSC			5,7	28.00 BSC			5,7	28.00 BSC			5,7
E2	25.35 REF				25.50 REF				25.50 REF			
ccc	---				0.08				---			
e	0.65 BSC				0.50 BSC				0.50 BSC			
N	160				208				208			
NOTE	1 , 8 , 16.1				1 , 8				1 , 8 , 16.2			
REF	---				11-288				---			
ISSUE	---				A				---			

FOR REVISION UPDATE PLEASE REFER TO HISTORY OF CHANGES.

 **Carsem** Your Technology Partner

REV
F

DWG NO: PKGMQ0001	
APP'D	KH LEE
CHECKED	ARAVEN
DESIGNED	ARAVEN
DRAWN	KHALIM

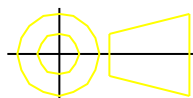

FILE: \PKGMQ0001
MQFP PACKAGE OUTLINE
SHEET : 10 OF 12

VARIATIONS												
SYMBOL	MO-143			NOTE	NJR			NOTE	MS-022			NOTE
	GA				ZZ9				BC			
	SQUARE				SQUARE				SQUARE			
	MIN	NOM	MAX		MIN	NOM	MAX		MIN	NOM	MAX	
A	3.45	3.70	4.10		1.80	2.13	2.45		1.80	2.15	2.45	
A1	0.25	0.30	0.50		0.00	0.13	0.25		0.00	0.15	0.25	
A2	3.20	3.40	3.60		1.80	2.00	2.20		1.80	2.00	2.20	
b	0.17	---	0.27	9	0.38	---	0.53	9	0.22	---	0.38	9
b1	0.17	0.20	0.23		0.38	0.43	0.48		0.22	0.30	0.33	
D	34.60 BSC			4	13.90 BSC			4	17.20 BSC			4
D1	32.00 BSC			5,7	10.00 BSC			5,7	14.00 BSC			5,7
D2	29.50 REF				6.35 REF				12.35 REF			
E	34.60 BSC			4	13.90 BSC			4	17.20 BSC			4
E1	32.00 BSC			5,7	10.00 BSC			5,7	14.00 BSC			5,7
E2	29.50 REF				6.35 REF				12.35 REF			
ccc	0.08				---				0.13			
e	0.50 BSC				1.27 BSC				0.65 BSC			
N	240				24				80			
NOTE	1 , 8				1 , 8 , 16,3				1 , 8			
REF	11-288				---				11-320			
ISSUE	A				---				A			

VARIATIONS												
SYMBOL	NJR			NOTE	NJR			NOTE	NJR			NOTE
	ZZ10				ZZ11				ZZ12			
	SQUARE				SQUARE				SQUARE			
	MIN	NOM	MAX		MIN	NOM	MAX		MIN	NOM	MAX	
A	1.80	2.13	2.45		2.20	2.30	2.45		2.20	2.30	2.45	
A1	0.00	0.13	0.25		0.25	0.30	0.35		0.25	0.30	0.35	
A2	1.80	2.00	2.20		1.95	2.00	2.10		1.95	2.00	2.10	
b	0.38	---	0.53	9	0.38	---	0.53	9	0.38	---	0.53	9
b1	0.38	0.43	0.48		0.38	0.43	0.48		0.38	0.43	0.48	
D	13.20 BSC			4	13.20 BSC			4	13.90 BSC			4
D1	10.00 BSC			5,7	10.00 BSC			5,7	10.00 BSC			5,7
D2	6.35 REF				6.35 REF				6.35 REF			
E	13.20 BSC			4	13.20 BSC			4	13.90 BSC			4
E1	10.00 BSC			5,7	10.00 BSC			5,7	10.00 BSC			5,7
E2	6.35 REF				6.35 REF				6.35 REF			
ccc	---				---				---			
e	1.27 BSC				1.27 BSC				1.27 BSC			
N	24				24				24			
NOTE	1 , 8 , 16.2				1 , 8 , 16.2				1 , 8 , 16.3			
REF	---				---				---			
ISSUE	---				---				---			

FOR REVISION UPDATE PLEASE REFER TO HISTORY OF CHANGES.

 **Carsem** Your Technology Partner

REV
F

DWG NO: PKGMQ0001

APP'D	KH LEE
CHECKED	ARAVEN
DESIGNED	ARAVEN
DRAWN	KHALIM

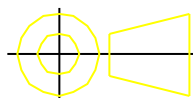

FILE: \PKGMQ0001

MQFP
PACKAGE OUTLINE

SHEET : 11 OF 12

VARIATIONS												
SYMBOL	NJR			NOTE	NJR			NOTE	MS-022			NOTE
	ZZ13				ZZ14				BF			
	SQUARE				SQUARE				SQUARE			
	MIN	NOM	MAX		MIN	NOM	MAX		MIN	NOM	MAX	
A	2.20	2.30	2.45		2.20	2.30	2.45		2.50	2.95	3.15	
A1	0.25	0.30	0.35		0.25	0.30	0.35		0.00	0.15	0.25	
A2	1.95	2.00	2.10		1.95	2.00	2.10		2.50	2.80	2.90	
b	0.30	---	0.45	9	0.22	---	0.38	9	0.30	---	0.45	9
b1	0.30	0.35	0.40		0.22	0.30	0.33		0.30	0.35	0.40	
D	13.20 BSC			4	13.20 BSC			4	17.20 BSC			4
D1	10.00 BSC			5,7	10.00 BSC			5,7	14.00 BSC			5,7
D2	8.00 REF				7.80 REF				12.35 REF			
E	13.20 BSC			4	13.20 BSC			4	17.20 BSC			4
E1	10.00 BSC			5,7	10.00 BSC			5,7	14.00 BSC			5,7
E2	8.00 REF				7.80 REF				12.35 REF			
ccc	0.20				0.13				0.13			
e	0.80 BSC				0.65 BSC				0.65 BSC			
N	44				52				80			
NOTE	1 . 8 , 16.2				1 . 8 , 16.2				1 . 8			
REF	- - -				- - -				11-320			
ISSUE	- - -				- - -				A			

VARIATIONS												
SYMBOL	NJR			NOTE	NJR			NOTE	NJR			NOTE
	ZZ15				ZZ15				ZZ15			
	RECTANGULAR				RECTANGULAR				RECTANGULAR			
	MIN	NOM	MAX		MIN	NOM	MAX		MIN	NOM	MAX	
A	2.55	2.80	3.00									
A1	0.00	0.10	0.20									
A2	2.55	2.70	2.80									
b	0.22	---	0.38	9								
b1	0.22	0.30	0.33									
D	23.60 BSC			4								
D1	20.00 BSC			5,7								
D2	18.85 REF											
E	17.60 BSC			4								
E1	14.00 BSC			5,7								
E2	12.35 REF											
ccc	0.15											
e	0.65 BSC											
N	100											
NOTE	1 , 8 , 16.4											
REF	- - -											
ISSUE	- - -											

FOR REVISION UPDATE PLEASE REFER TO HISTORY OF CHANGES.

 **Carsem** Your Technology Partner

REV
F

DWG NO: PKGMQ0001

APP'D	KH LEE
CHECKED	ARAVEN
DESIGNED	ARAVEN
DRAWN	KHALIM

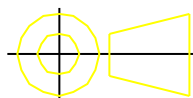

FILE: \PKGMQ0001

MQFP
PACKAGE OUTLINE

SHEET : 12 OF 12